

—with thanks to Nancy Stewart

A

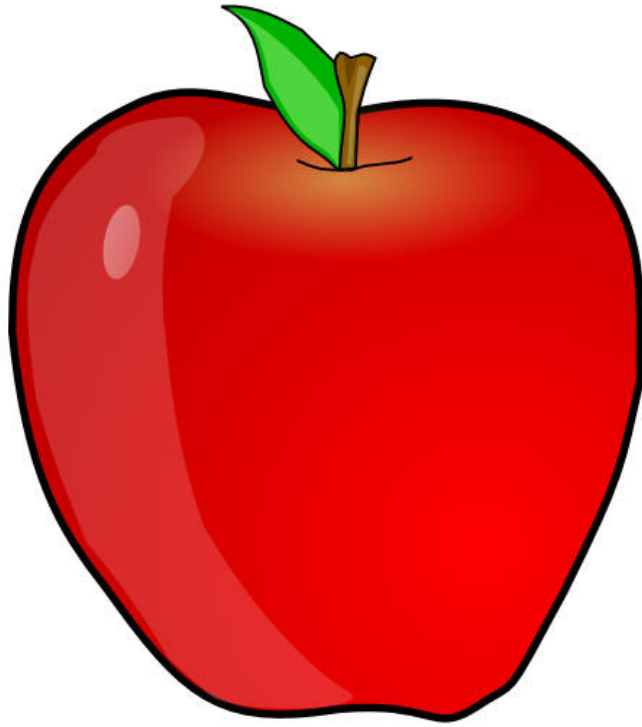

Apple

a

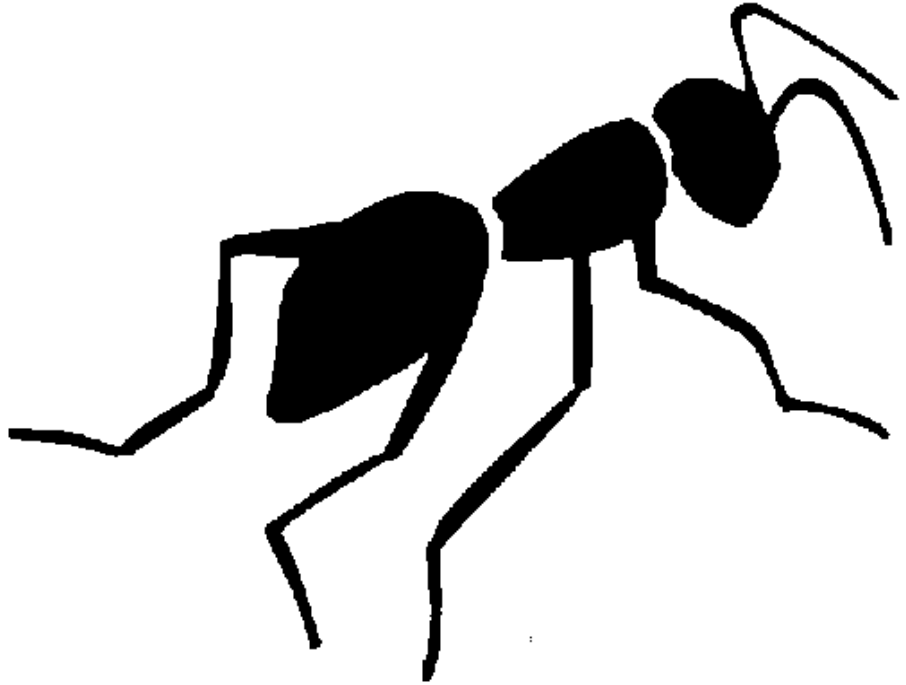

ant

B



Bandicoot

b

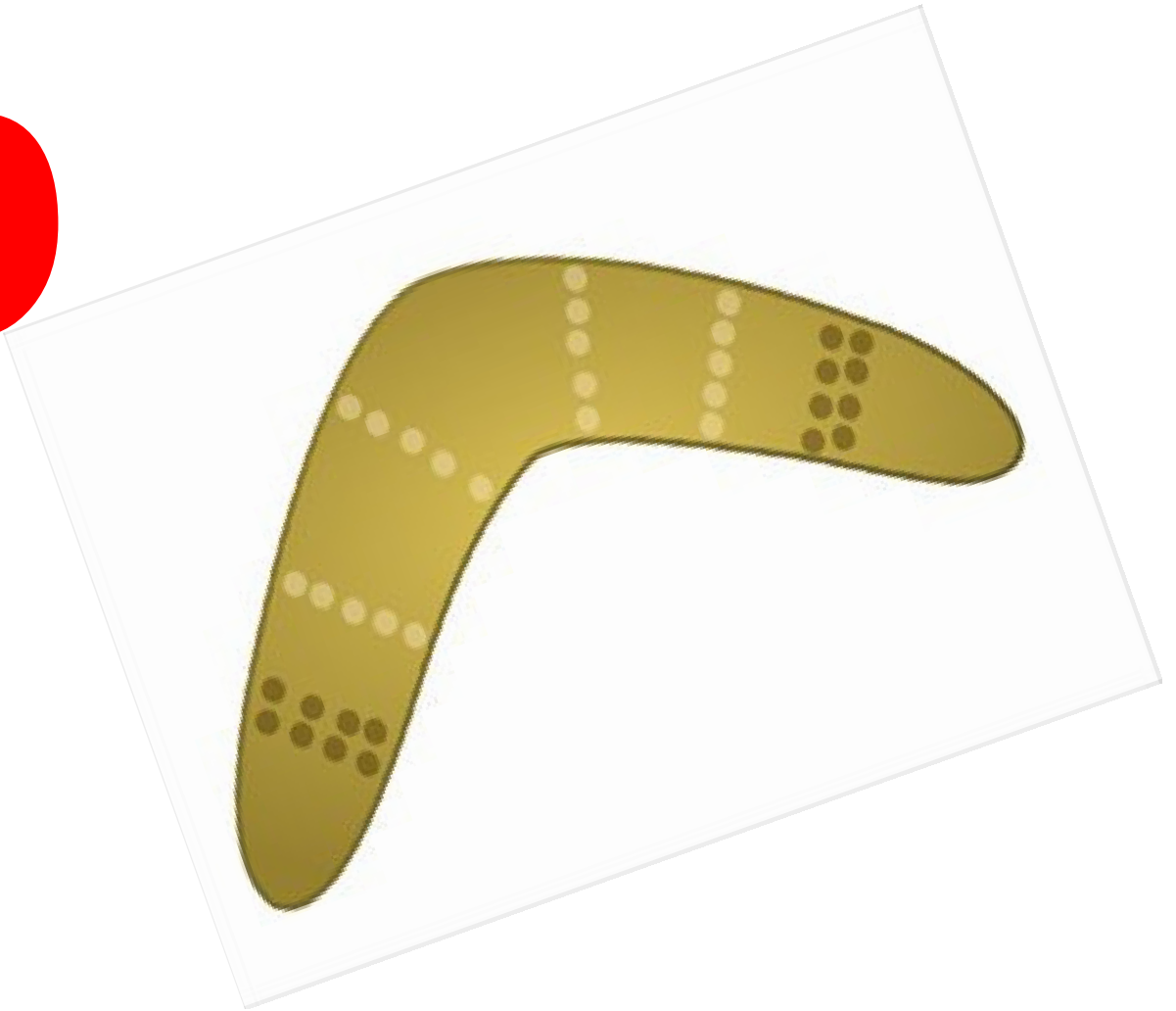

boomerang

C

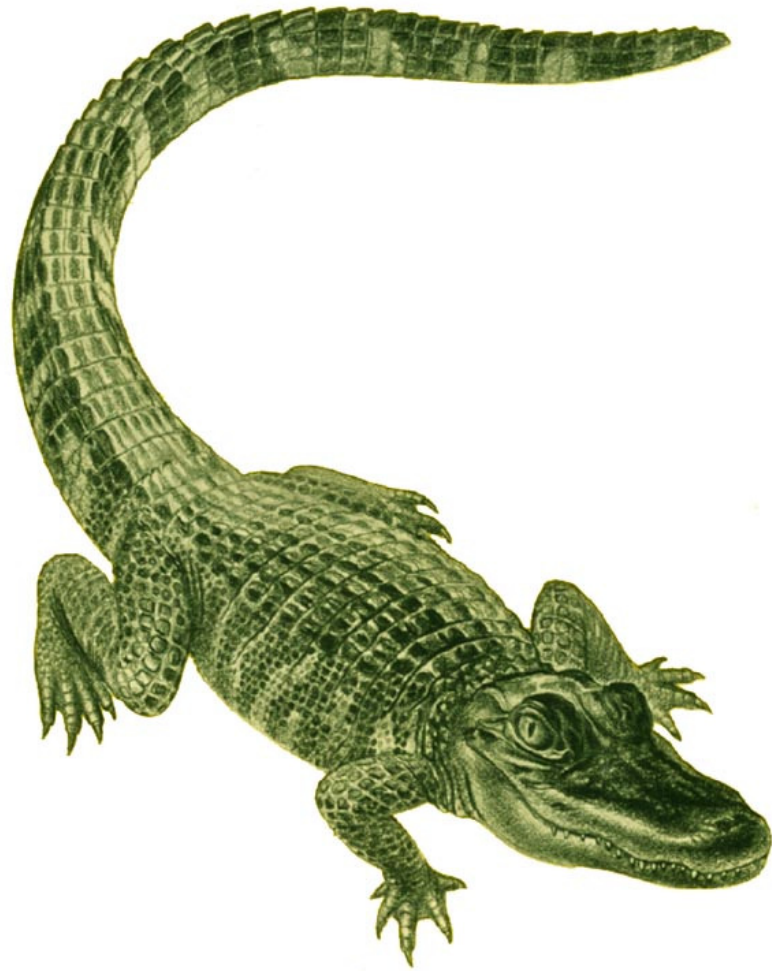

Crocodile

C



chook

D



Dingo

d



didgeridoo

E

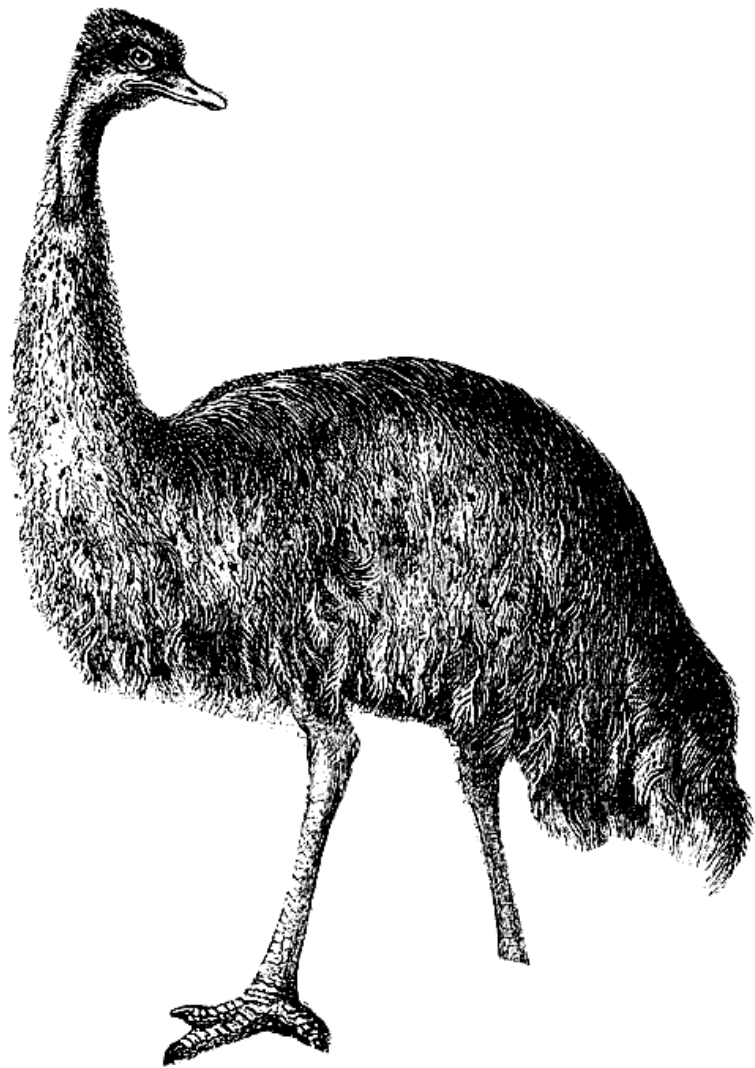

Emu

e



e chidna

F



Floaties

f



frog

G



Galah

g

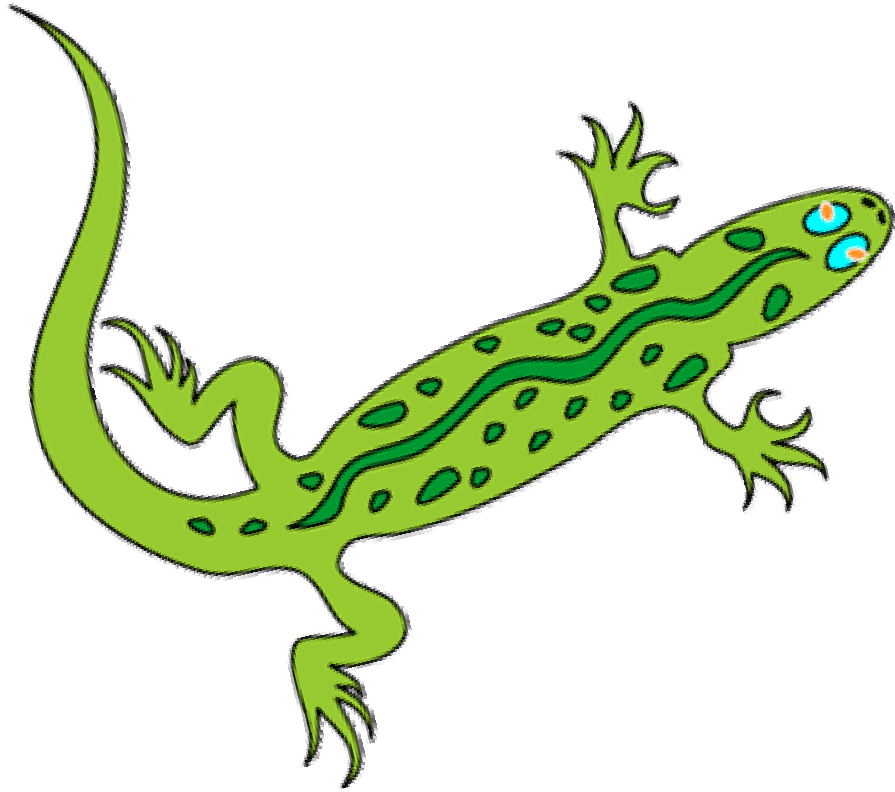

gecko

H



Hawk

h



huntsman

I



Ibis

i

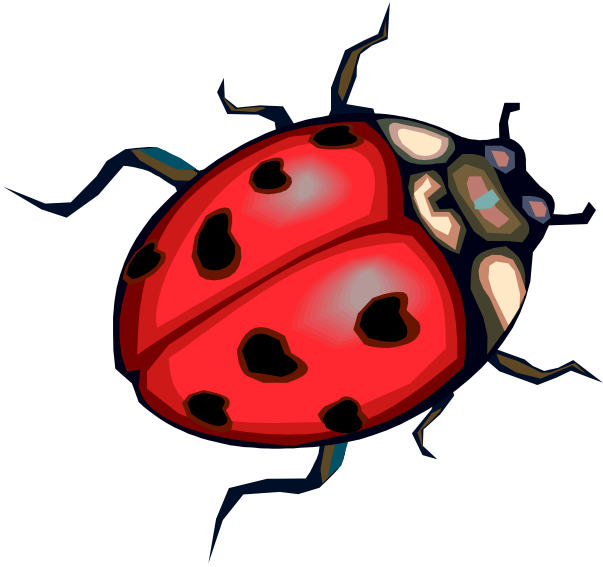
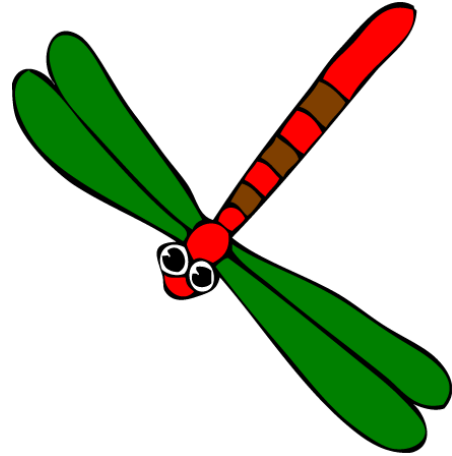

i
insects

J



Joey

j



jumper

K



Koala

k



kookaburra

L



Lyrebird

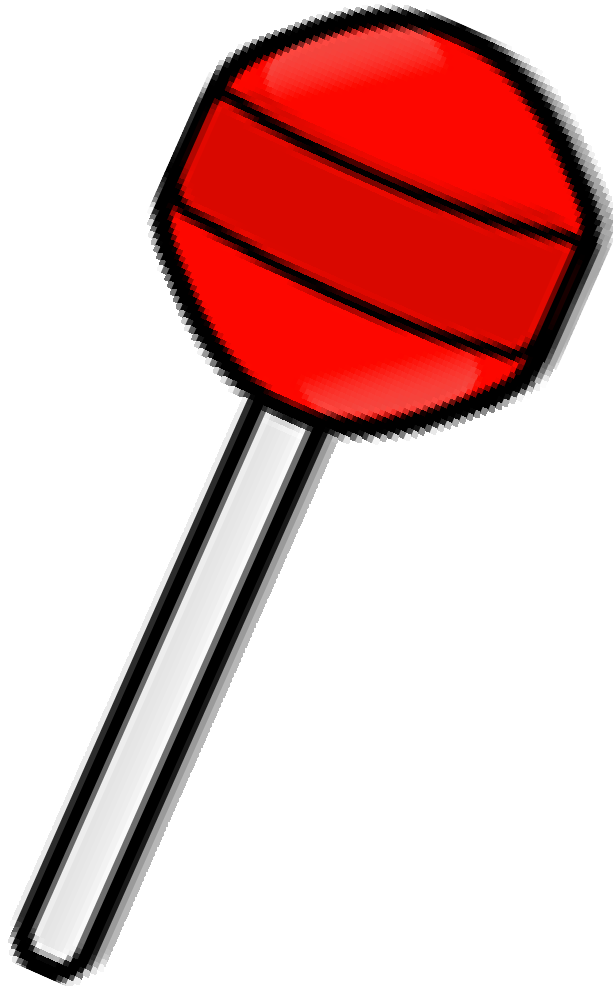

lollipop

M



Magpie

m



mackerel

N



Numbat

n



nappy

O



Octopus

O



outback

P



Prawn

p



platypus

Q



Quoll

q



quokka

R



Redback

r



rosella

S



Slater

S



s starfish

T

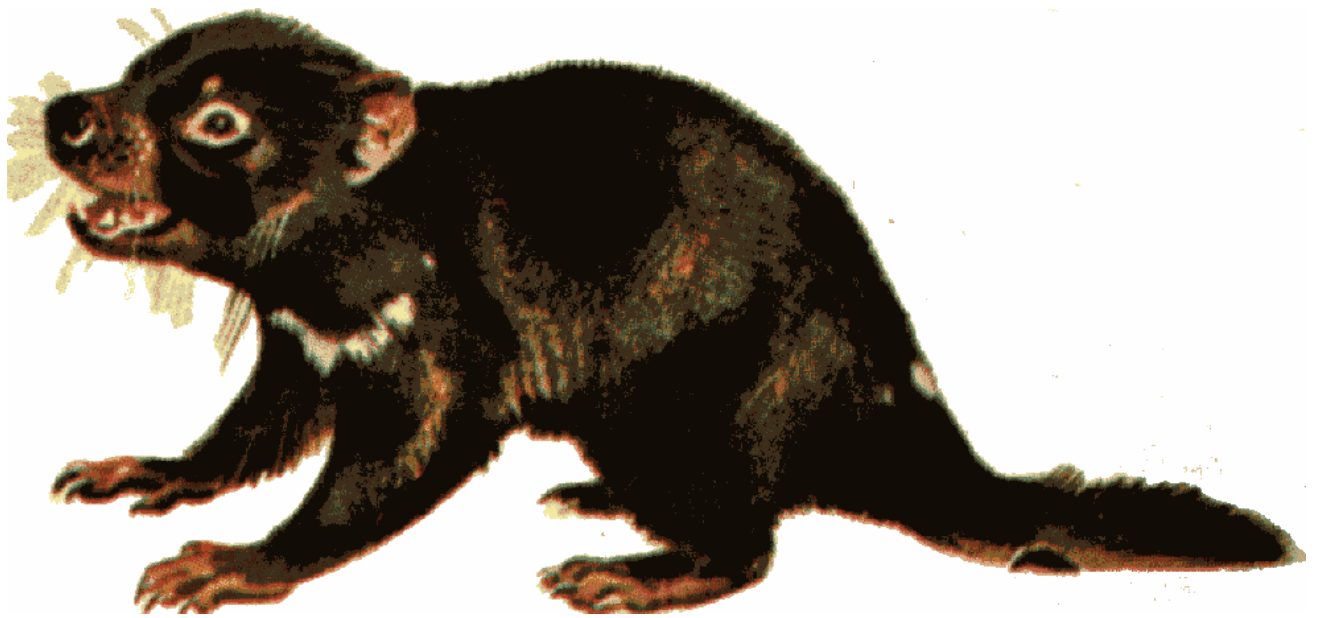

Tasmanian devil

t

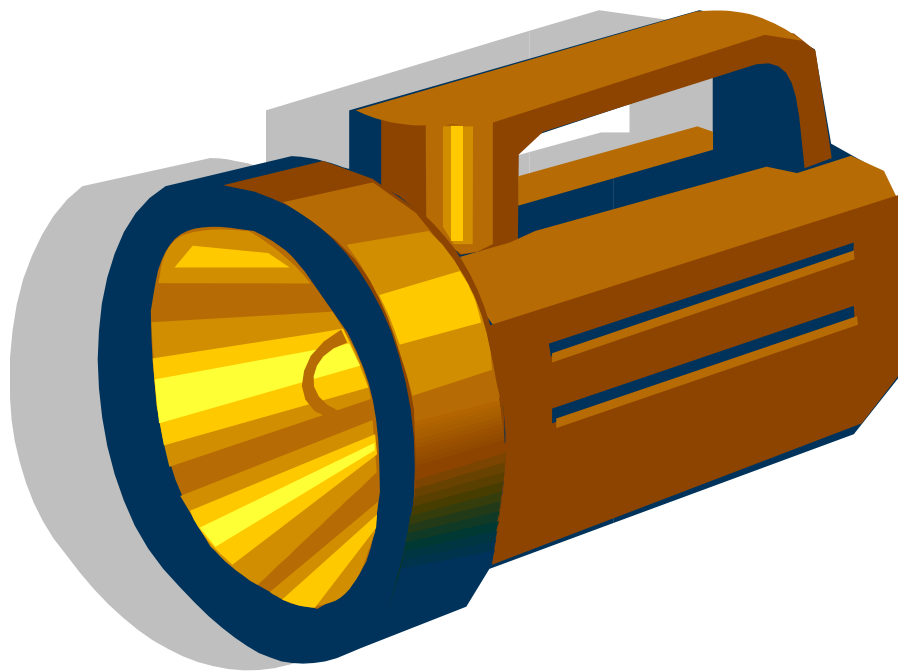

torch

U



Ute

u



uluru

V



Vegemite

V

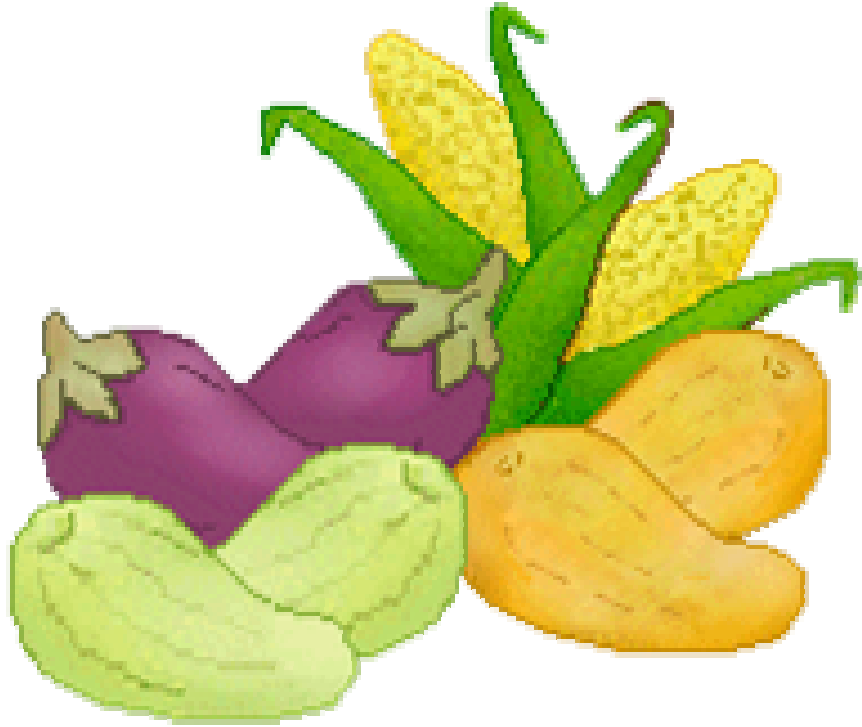

veggies

W



Wombat

W



wattle

X



X-ray

X



xxylophone

Y

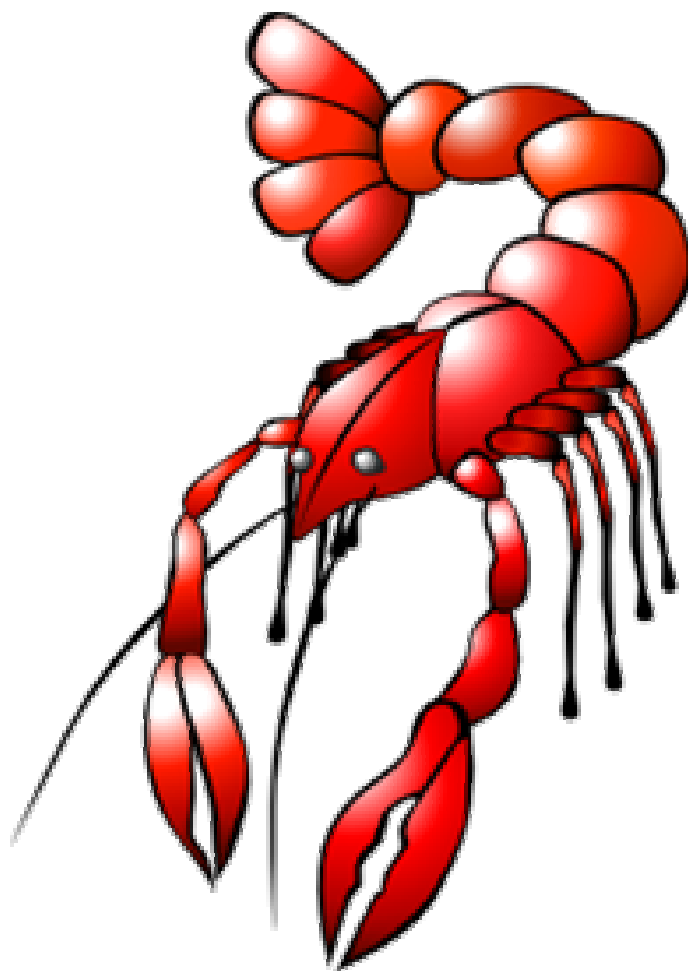

yabby

y



yacht

Z



Zipper

Z



zebra